

G.T.集团保留对所示产品进行修改或改进的权利,恕不另行通知 - 所示产品的可用性可能会更改 - 本用户指南中描述的产品仅代表STEG产品的一部分 - 所有品牌和商标均仅用于描述目的,所有权利属于各自所有者 - 全部或部分,禁止复制本用户指南。

G.T.trading reserves the right to make modifications or improvements to the products illustrated without notice thereof - The availability of the products illustrated is subject to change - The products described in this User's Guide represent just a part of the STEG products available - All brands and trademarks mentioned have been used exclusively for description purposes and all rights belong to the respective owners - Total or partial

COMPETITION AMPLIFIERS

DST1000II

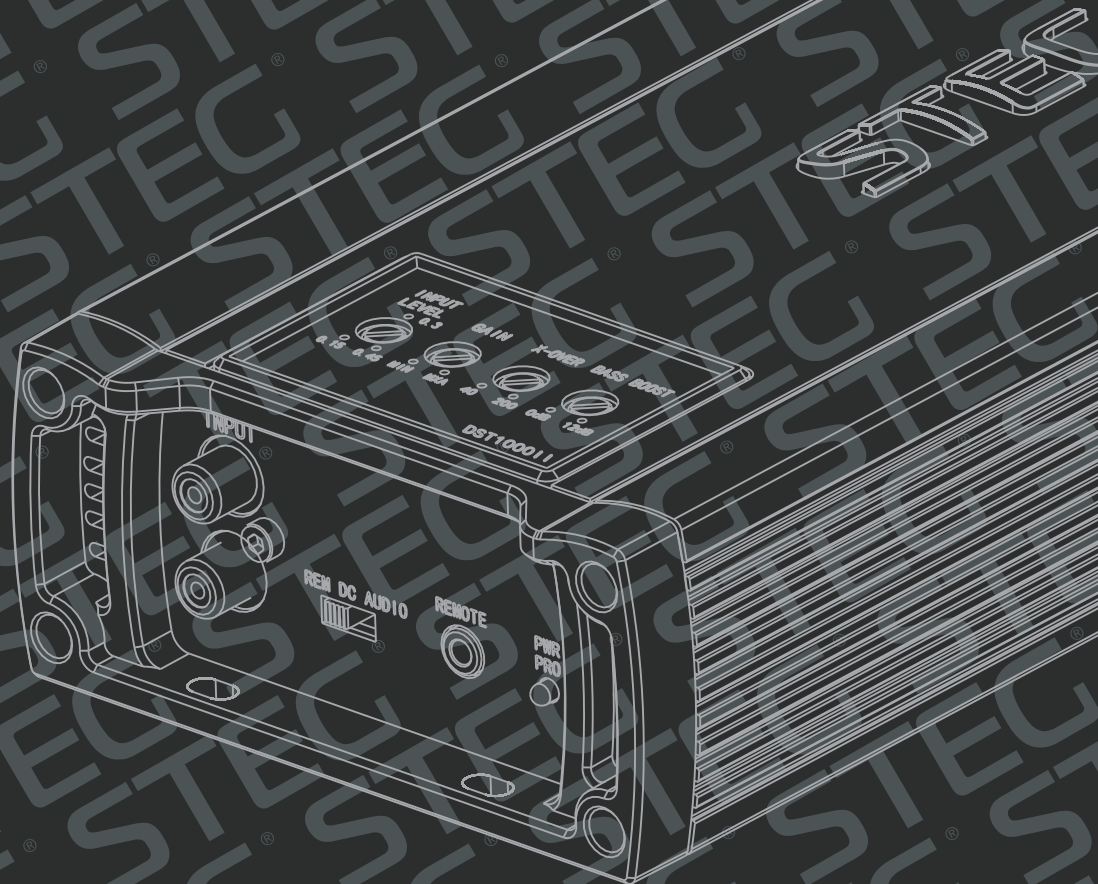

使用指南

单声道汽车音响功率功放

USER'S GUIDE

Mono car audio power amplifier

中文

简介

感谢您选择此音响设备来满足您的功放需求。近年来功放已被大大改善，确保其质量和可靠性。每个产品都应用了最新的技术，为您提供难以置信的音效和无与伦比的音质。简洁，高度发达的电路有助于低失真和极高的效率。这就是为什么我们确信您的新功放将为您提供良好体验的价值。

GB

INTRODUCTION

Thanks and congratulations for choosing this mobile audio for your amplification needs. The amplifiers have been significantly improved throughout years to assure quality and reliability. The latest technology has been incorporated into every product providing you with incredible power and unparalleled sound quality. Our simple, highly developed circuitry contributes to low distortion and the ultimate in efficiency. That's why we are sure that your new amplifier will provide you with a sound value you can enjoy for years to come.

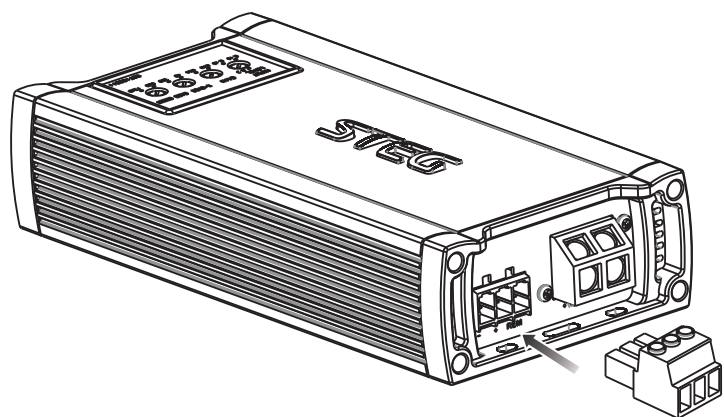
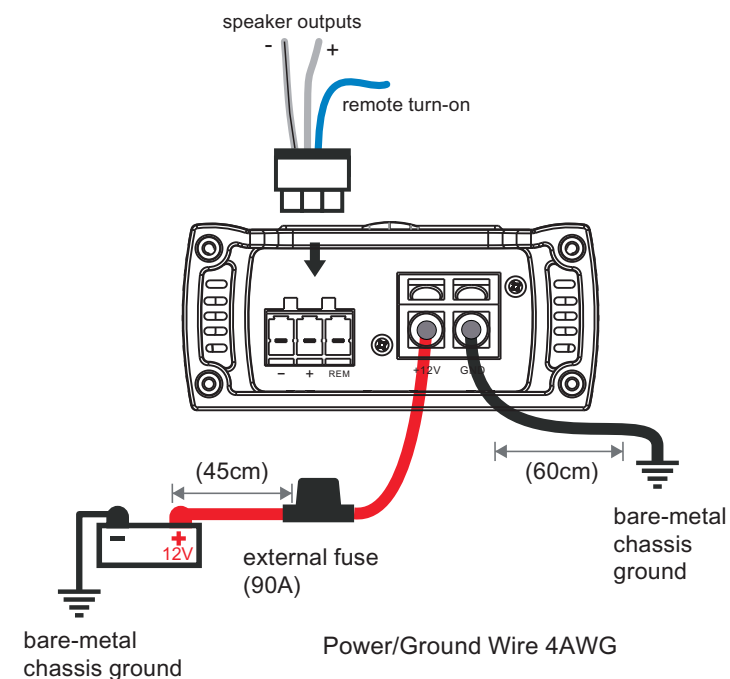
GB**DST1000II POWER WIRING****中文****注意事项**

- 如果将功放安装到驾驶室，请尽量注意。
 - 仅在带有12伏负极接地的汽车中使用。
 - 在接线之前，请断开电池与负极电缆的连接，以避免短路或触电。建立正确的连接。
 - 由于容量不足，请勿将功放的正极和负极电缆连接到汽车的原有电缆。
 - 钻孔时不要损坏管道或接线。
 - 安排布线，不要让线割伤或被尖锐的金属边缘夹住。
 - 请勿将功放安装在可能阻碍车辆操作的地方，也不要安装在有水气的地方。
- 使用功放随附的安装材料。
- 请勿在制动器，安全气囊或其他安全相关系统中使用螺栓或螺母进行接地连接。
 - **警告！**功放可能产生超过导致听力损失阈值的声压级。也可能会损害驾驶员听到交通声音或紧急车辆声音的能力。使用音响系统时，请注意安全听音。
- 当功放在特殊艰难的环境下工作时，其温度可以高达90°C。在触摸之前确保其温度的安全。该功放仅适用于机动车辆。

GB**PRECAUTIONS**

- Pay utmost attention if you install the amplifier into the driver's compartment.
- Use Only in cars with a 12 Volt negative ground.
- Before wiring, disconnect the cable from the negative battery terminal to avoid short circuits or electrical shocks. Make the correct connections.
- Do not connect the positive and negative cable of the amplifier to the original cables of the car because of its low capacity.
- Do not damage pipe or wiring when drilling holes.
- Arrange the wiring so it is not crimped or pinched by a sharp metal edge
- Do not install the amplifier in locations which might hinder vehicle operations and do not install in locations with any moisture. Use the installation materials provided with the amplifier.
- Do not use bolts or nuts in the brake, airbags or other safety relevant systems to make ground connections.
- **Warning!** Amplifiers may produce sound pressure levels that exceed the threshold at which hearing loss may result. They may also impair a driver's ability to hear traffic sounds or emergency vehicles. Practice safe listening when listening to your audio system.

When the amplifier works in particularly hard conditions, it can research up to 90 °C . Make sure its temperature is safe before touching it. This amplifiers are developed for motor vehicle use only .

GB**DST1000II TECHNICAL SPECIFICATIONS****中文****DST1000II 技术规格****Power Supply**

电源

Power supply voltage 电源电压 : 6-20 VDC

Amplifier Stage

功放级

Output power(RMS) @ 14, 4V / 4Ω 输出功率 (RMS) @ 14, 4V / 4Ω : 500 Watt x 1

Output power(RMS) @ 14, 4V / 2Ω 输出功率 (RMS) @ 14, 4V / 2Ω : 1000 Watt x 1

Output power(max) @ 14, 4V / 4Ω 输出功率 (最大) @ 14, 4V / 4Ω : 1000 Watt x 1

Output power(max) @ 14, 4V / 2Ω 输出功率 (最大) @ 14, 4V / 2Ω : 2000 Watt x 1

Distortion (THD) 失真 (THD) : <0.08% 4Ω/250W

S/N Ratio S / N 比 : >95dB 额定功率

Input sensitivity 输入灵敏度 : 150mV-3.5V
: 300mV-7V
: 1.2V-28V**Filters**

滤波器

Low pass filter / slope 低通滤波器/斜率 : 50 Hz-200Hz/12dB

Subsonic filter/slope 次低音滤波器/斜率 : 25 Hz/24dB

Bass Boost Frequency 低音提升频率 : 0 - 12dB / 45Hz

Other Functions

其它功能

Max size (WxHx L) 最大尺寸 (WxHxL) : 324x110x50mm

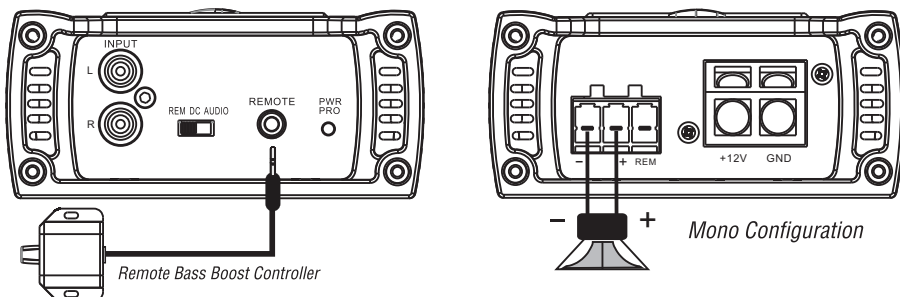
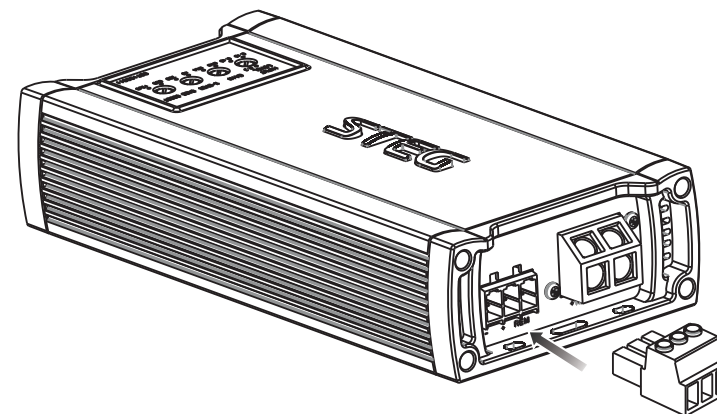
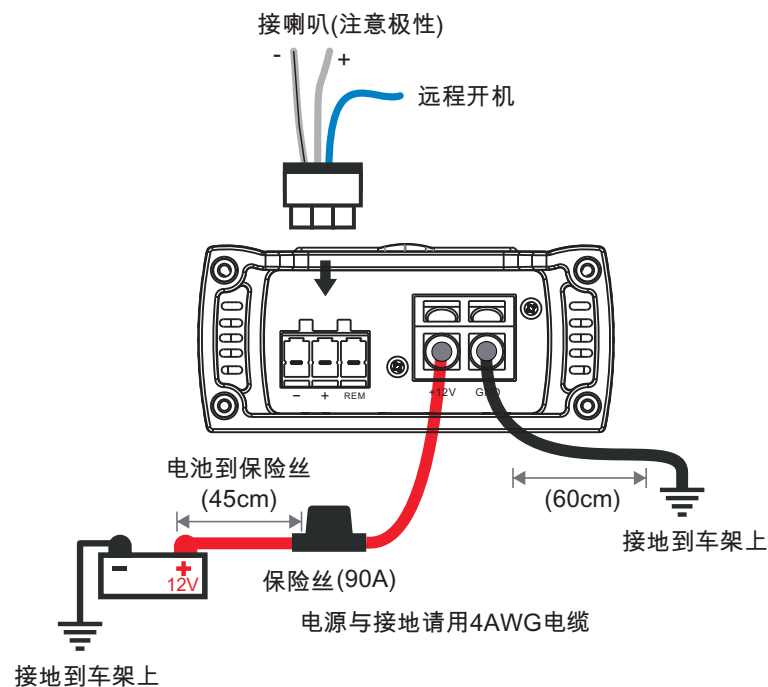
DST1000II CONFIGURATION SAMPLES**中文****DST1000II 电源接线图**

DST1000II REAR PANEL

1. Speaker Terminal
Connect the (+) and (-) clamps to your subwoofers. Be sure of right polarity.
Warning! Never connect the speaker cables to the vehicle body.
Don't use speaker impedance lower than 2 Ω.

▪ REMOTE: Connect the remote terminal to the remote output of your headunit. The amplifier automatically turns on as soon as a signal is received(TURN ON). The remote connection of the power - terminal(REM) won't be used.

2. Power Terminal

▪ GROUND: Connect the GND terminal to the chassis ground.
Please use a 4AWG cable or bigger. The max length of the ground wire has to be 1m.

▪ +12V: Connect this terminal to the battery "+" (Plus)- Pole.
Please use a 4AWG cable or bigger. Always protect this wire by installing a fuse within 45 cm of the battery terminal connection.

See Page 9

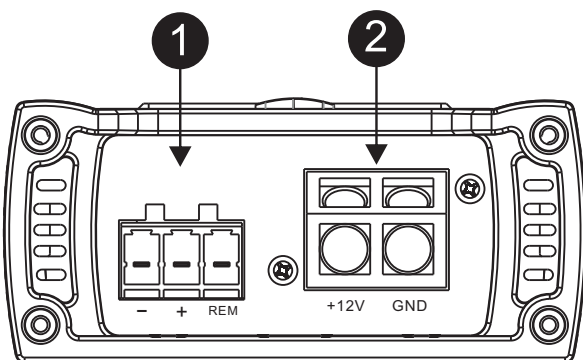



DST1000II REAR PANEL

DST1000II 前面板

1. **BOSST** 提升旋钮
当旋转此旋钮时,声音在45Hz提升0-12dB.
 0dB 12dB

2. **X-OVER** 低通频响旋钮
当旋转此旋钮低通频率响应在50Hz-200Hz之间变化。
 50 200



3. **GAIN** 音量控制旋钮
MIN:当旋钮在此位置时,声音最小。
MAX:当旋钮在此位置时,声音最大。
 MIN MAX

4. **INPUT LEVEL** 灵敏度选择旋钮
1:当旋钮在此位置时,灵敏度为150mV-3.5V.
2:当旋钮在此位置时,灵敏度为300mV-7V.
3:当旋钮在此位置时,灵敏度为1.2V-28V。
 1/2/3

5. **LED指示灯**
当此灯为蓝色时,功放正常工作。
当此灯为红色时,功放进入保护状态,有可能是温度过热保护、欠压保护、输出短路保护。
 PWR PRO

6. **REMOTE** 遥控插座
插入遥控器后,旋转遥控器上的旋钮,可控制声量大小。





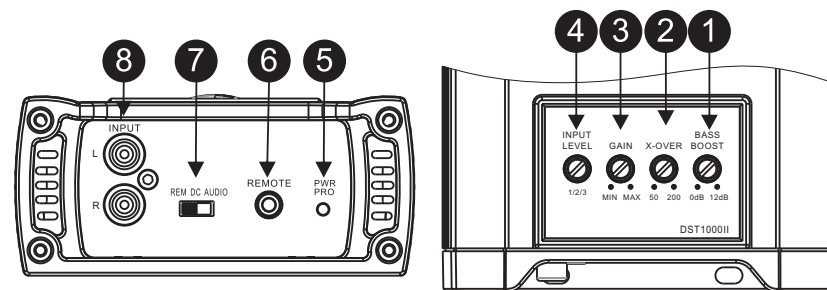



7. **REM DC AUDIO** 开机模式
1. REM-远程开机。
2. DC-高电平开机。
3. AUDIO-音乐开机。



8. **INPUT** RCA信号输入
用信号线连接到汽车上的主设备(AM/FM/CD)输出端。
L 
R 



DST1000II FRONT PANEL

DST1000II FRONT PANEL

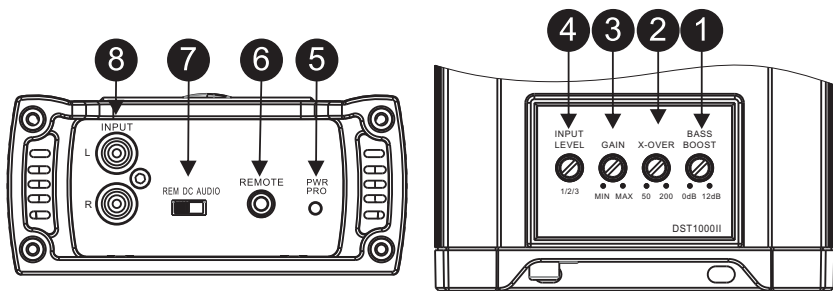
1. **BASS BOOST**

Bass boost
 The variable bass boost control is designed to give you increased output, 0-12dB , at 40 Hz.
2. **X-OVER**

X-over
 The variable crossovers on the top of the amplifier allow you to adjust the crossover frequency from 50Hz - 500Hz.
3. **GAIN**

Gain control
 This control allows you to adjust the overall volume output level, with Min decreasing the volume, and Max increasing.
4. **INPUT LEVEL**

Input level
 The input level control is used to adjust the input sensitivity, the adjustment range is from 150mV-28V.
 At position 1, the sensitivity is from 150mV - 3.5V.
 At position 2, the sensitivity is from 300mV - 7V.
 At position 3, the sensitivity is from 1.2V - 28V.
5. **Power-on indicator (PWE/PRO)**

 Blue LED on: Power amplifier working normally.
 Red LED on: Power amplifier went into protection status.
 (It could be over heating protection, under voltage protection or output short circuit protection.)
6. **REMOTE**

Remote
 Connect the remote, adjust the control of the remote to control the volume level.
7. **Turn-on modes**

 1. REM-Remote turn - on.
 2. DC-High Level turn - on
 3. AUDIO-Audio turn - on
8. **INPUT**

RCA Signal Input
 Connect the output terminals of major device (AM / FM / CD) on vehicles by using signal cables.



DST1000II FRONT PANEL

DST1000II 后面板

1. 扬声器终端
 将 (+) 和 (-) 夹子连接到低音扬声器上, 确保极性。
警告! 不要将扬声器电缆连接到车身。扬声器阻抗不要低于2Ω。
 ■ 远程: 将远程终端连接到您音响主机的远程输出。使用高电平输入时, 机器一旦接收到信号, 功放自动打开 (TURN ON)。电源端子 (REM) 的远程连接将不被使用。
2. 电源终端
 ■ 接地: 连接GND端子/机箱接地。
 请使用4AWG电缆。地线的长度请参考接线图 (见第8页)。
 ■ +12V: 将此端子连接到电池" + " 正极。
 请使用4AWG电缆。通过在电池端子连接45厘米内安装保险丝来保护电线。

见第8页

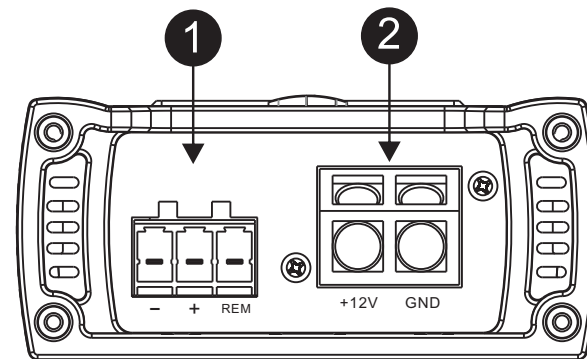

DST1000II REAR PANEL